



LABFACILITY

TEMPERATURE & PROCESS TECHNOLOGY

Tempmaster PRO High Precision Digital Thermometer / Logger for Pt100 Sensors



User Manual



RoHS compliant



Certificate No. 4746

www.labfacility.co.uk

Contents

1. About the Tempmaster PRO	3
2. Installation	5
a. Supply Connection	5
b. Communication Interface	5
c. Sensor Connection	6
3. Stand Alone Operation	7
a. To read sensor temperature directly	9
b. To read differential temperature	9
c. Matching Tempmaster PRO to calibrated sensors	10
d. SMART probe operation	11
e. Temperature measurement with calibrated sensor	11
f. Using Tempmaster PRO to obtain a secondary sensor calibration	12
g. On-board logging	13
h. Error indications	13
i. 3 or 4 wire recognition (Pt100)	14
j. Variable filter rate	14
4. Operation with a PC	15
a. Install the software	15
b. Control panel	15
c. Sensor selection	16
d. Settings	16
e. Input channel	17
f. Units and resolution	17
g. Coefficients and corrections	17
h. Custom coefficients	18
i. SMART probe	19
j. Log	19
k. Memory	20
5. Analogue D to A output	20
6. Instrument Re-Calibration	21
7. Specifications	23

Information in this publication may be subject to change; the Tempmaster PRO is a micro-processor based, software driven instrument and may therefore be subject to software and hardware changes in line with our policy of continuous product development.

I. About the Tempmaster PRO

The Tempmaster PRO is a successor to the very successful Tempmaster-100 thermometer developed over a 25 year period. Like its predecessor, the Tempmaster PRO provides laboratory standard temperature measurement with Pt100 sensors and greater versatility to extend the scope of applications.

Displayed values and user information are indicated on a bright clear OLED screen with diffused backlighting. Data can be displayed in °C, °F, K, Ω as required; nine front panel push keys, the only user controls, are used in conjunction with the display screen. It is this arrangement which makes for very simple and “friendly” operation.

Resolution is 0.01°C: all computations are performed digitally without drift. Overall stability is optimised by utilising only the highest quality components including high precision, expensive metal film resistor networks.

There are two input ports for 3 or 4 wire Pt100 sensors; the instrument automatically recognises 3 or 4 wire configurations. The measured temperature can be displayed directly from one of the inputs or differentially between the two inputs. Differential temperature and the two individual channel temperatures are displayed simultaneously.

Individual calibrated sensors can have their appropriate calibration values programmed into the Tempmaster PRO using either the keypad or the PC software supplied. The PC software also allows corrections in the form of constants for individual Pt100 sensors to be programmed in. The non-volatile memory ensures that the values are retained (until such time as they are changed) even after switch-off. Where the calibration certificate relating to a particular probe states specific Ω values at stated temperatures, up to ten such values are entered into the Tempmaster PRO with their relevant temperature points using the front panel keypad or the software. The instrument then digitally self-calibrates to the associated probe over the range embraced in the calibrated values used; the temperature readout is “corrected” accordingly. Additional manual procedures are not required to compute precise temperature readings since these are displayed directly; miscalculation errors are thus eliminated. Very high system accuracies, better than 40 milliKelvins can be achieved using probe matching.

Corrections which are “programmed in” can be displayed for confirmation. However, initial input, adjustment, enabling and disabling of corrections are protected For by a special key sequence to prevent accidental or unauthorised changes. Values can be changed by an authorised user at any time.

Tempmaster PRO Thermometer

For the Pt100 inputs, SMART probes can be used which incorporate dedicated ‘correction values’ within the connector of each probe. When a SMART probe is connected to input A or B or both inputs, the corrections are automatically applied without the need for user intervention.

A common application for the Tempmaster PRO is the comparison calibration of “working” sensors against a calibrated reference standard or semi-standard sensor. For example, the sensor under test in channel B is compared against the reference sensor (with programmed corrections) in channel A.

When applied, the null function corrects the differential temperature readout between two sensors to zero. For example, the apparent temperature difference between two sensors known to be at the same actual temperature can be corrected to zero prior to, for example, heat exchanger experiments.

Both inputs can be scanned and values logged according to parameters set up by the user in the PC software; the instrument incorporates a real-time clock and on-board memory.

The adjustable contrast OLED display screen provides data readout, user prompts and mode annunciation. This very important feature ensures a high degree of user friendliness and confidence. User prompts indicate which buttons to press in the appropriate sequence when selecting parameters and functions and when setting calibration values. Mode annunciation indicates which mode of operation is currently selected.

A flash drive USB port is provided to allow data to be stored and/or exported. Firmware update are also facilitated via this port.

PC software running in WINDOWS is provided as standard; it allows programming of custom calibration, remote control & measure and logging functions.

2. Installation

The instrument is for bench-top and portable use, folding 'legs' can be extended to provide a convenient viewing angle.

All connections are made to the rear panel as indicated.

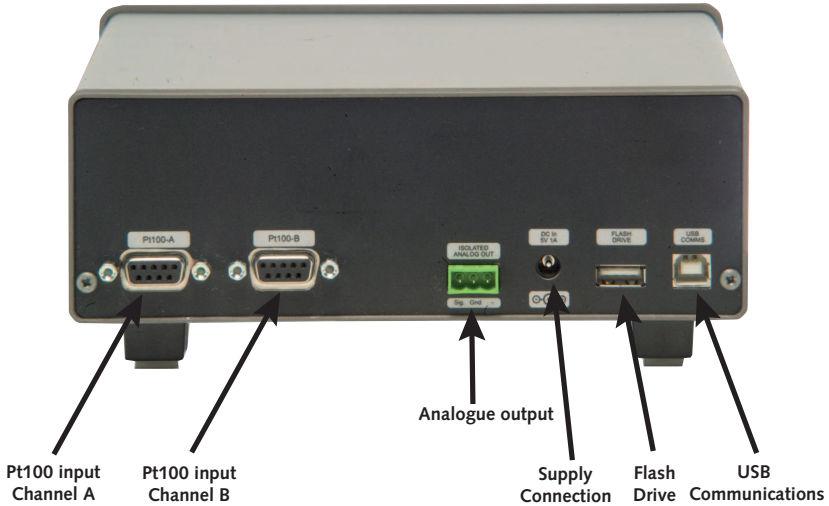

2a Supply Connection

Refer to the rear panel illustration. Primary power is provided by the internal Lithium Ion battery which provides up to 12 hours of operation from a full charge. The external 90 to 260V 50/60Hz power supply allows recharging and continuous operation. The output lead with its fitted connector is plugged in to the rear panel socket 'DC in 5V IA'.

Pressing the front panel 'POWER' key switches the instrument on / off.

The battery charge indicator in the top right of the display indicates the state of charge. The battery will charge whenever the instrument is connected to the power adaptor.

2b Communications Interface

Connect the USB cable supplied between the instrument and the PC. Refer to the rear panel illustration.

2c Input Connection – Sensors

Refer to the rear panel illustration.

Pt100 sensors

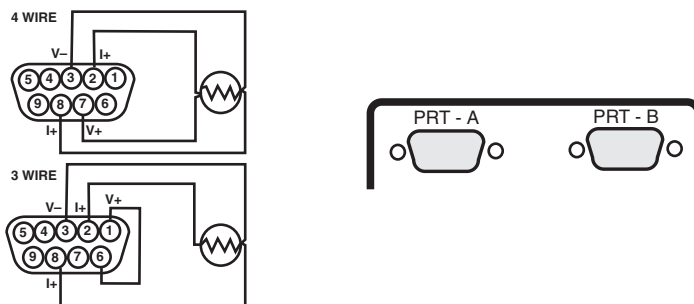

Platinum resistance thermometers must be fitted with a high quality D-plug and connected to input PRT-A and/or PRT-B as required. A 3 or 4 wire configuration can be used but they are connected differently as shown. The instrument will automatically sense which configuration is employed.

Special care must be taken when connecting 3 wire Pt100 terminations to the connector pins. A good crimp must be achieved to avoid Ohmic contacts which would result in reading errors. Only use good quality connectors with gold contact material; the Labfacility D type is recommended.

Application note: Inputs are not isolated in the Tempmaster PRO which is primarily designed for laboratory applications and site calibration of industrial temperature sensors. Probes connected to the instrument must therefore be isolated from high voltage pick-up.

The instrument should be disconnected from the mains adaptor and operated from its internal batteries in such conditions.

3. Operation



Ensure that the instrument is connected to a suitable supply and that the required connections are made.

Switch on using the 'POWER' key. The display will show the programme (software) designation followed by a short delay while the internal checks are carried out. The instrument will then commence normal operation according to the selected mode prior to switch-off, e.g. if channel B, PRT was in use when switched off, this will be the mode when switched on.

OPERATION requires the selection of appropriate menus which are shown on the display screen. Menu screens are obtained as shown in the following sections although the procedure is described in the text in each case.

Display brightness can be adjusted as required in the 'SETTINGS' sub-menu described later.

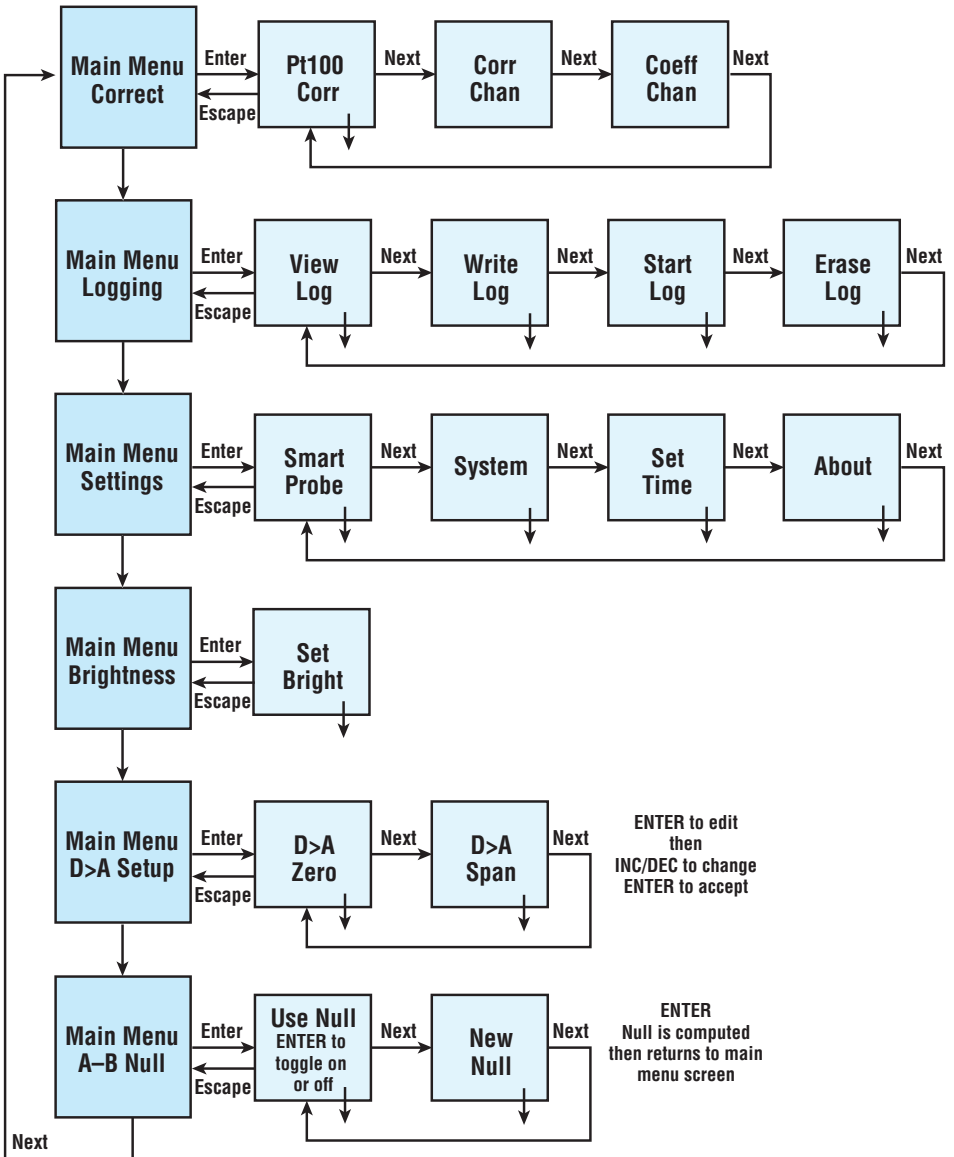

3a To read sensor temperature directly

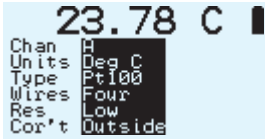

The screenshot shows the thermometer's display. At the top, it reads '23.78 C'. Below this, a table of sensor settings is displayed:

Chan	H
Units	Deg C
Type	Pt100
Wires	Four
Res.	Low
Cor't	Outside

Press 'SENSOR' key to select the required type of sensor if different to that currently indicated

Brief repeated key presses will step through the various types or holding the key depressed will auto-repeat (scroll through); this applies to other functions as well.

NOTE: If for any selected channel the sensor is either not connected (including sensor open circuit) the display will show 'BROKEN PROBE'.

Press 'CHANNEL' to select inputs A, B or A-B (differential)

Press UNITS to display the desired units °C, °F, K or Ω (dependent on the type of sensor selected).

Press 'RESOLUTION' to display the desired resolution, either 0.01 or 0.001 for °C, K and Ω only. Only 0.01 resolution can be used with °F.

3b To read differential temperature

The difference in temperature between two sensors can be obtained by displaying channel A-B. Ensure that the required sensors are connected to the appropriate A and B inputs.

Press 'CHANNEL' to select A-B after first setting up the individual channels A and B with sensor type and corrections ON/OFF as required. Press 'UNITS' to display the desired temperature units which must be appropriate to both types of sensor. The value now displayed is the difference value between sensors A and B as selected (i.e. A-B).

For calorimetry and certain other applications, to optimise the precision of such differential measurements, the probe tolerances can be nulled as follows:

Nulling procedure requires the relevant probes A and B to be tagged for repeatability. Ensure that both sensors are held at the same temperature (say 0°C or other value) and measure A-B.

It is possible to null out differences between the two sensors measured differentially as follows:

Obtain the 'NULL' menu A-B Null by scrolling through the sub-menus until the menu appears. Press 'ENTER'.

The display screen shows: **=USE NULL ON/OFF & VALUE=**

- i) Acquiring a new null
- ii) Applying a measured null value

The last null value will be applied such that the display value used is (A-B) – (Null value).

The display screen shows: **ACQUIRE NEW A-B
NULL VALUE (DEG C)
VALUE =**

3c Matching Tempmaster PRO to calibrated sensors

It is possible to automatically match the Tempmaster PRO to Pt100 sensors with dedicated calibration values via the PC software (see p17). Such values published in associated certificate indicate true Ω , °C and value corresponding to accurately known reference temperatures.

Viewing corrections via the keypad

- I. Obtain the required thermocouple (TC) or Pt100 (PRT) 'CORRECTIONS' menu; press 'MENU' and then 'CORRECT'. Press 'ENTER'.



Main Menu 
Correct

The display screen shows: **VIEW CORRECTIONS or VIEW CORRECTIONS
FOR THERMOCOUPLES FOR Pt100 SENSORS**

3d SMART probe operation

SmartProbe

View Smart-Probe Data

In the main menu, scroll down to 'SETTINGS' and press 'ENTER'. The smart probe screen is shown. Press 'ENTER' to view the Smart Probe data (table of values or coefficients). The probe tag and values are displayed when an appropriate probe is connected to the instrument.

```
smPROBE A S/No 1234
Deg C      Ohms
2.111      102.111
Point Number 01
```

For custom coefficients

In the correction menu, scroll down to 'COEFF' screens and follow the prompts to view values and to specify relevant channel (ie A / B / Both / off). Press ENTER to select.

Coef Chan

```
Select Coefficient
Pt100 correction Mode
Set to Off
```

3e Temperature Measurement with Calibrated Sensor

To use the Tempmaster PRO with its associated calibrated sensor, ensure that;

1. The appropriate sensor(s) is/are connected to the relevant input(s) A or B.
2. Select the relevant channel to suit, ensure that the correct sensor type is selected.
3. Then obtain 'correct' menu; press 'MENU'; the 'correct' menu is obtained. Scroll through options as required.

Main Menu

Correct

CORRECT	OFF
CORRECT	A
CORRECT	B
CORRECT	A+B

Press 'ENTER' to select.

Press 'ESCAPE' to return to the main display which will confirm the corrections status (CORRECT OFF OR CORRECTED).

There are eight annunciations to indicate the status of corrections when taking readings with the Tempmaster PRO:

Display screen

annunciation	Status
1) OFF	
2) N/A	(i.e. when units are mV or Ohms)
3) OUTSIDE	Tables either Local or Probe are selected but the current electrical measurement is beyond the electrical range defined in tables)
4) No Pts	(Tables selected, but no table found)
5) Local T	(Local tables i.e. in the instrument are applied)
6) Local C	(Local coefficients i.e. in the instrument are applied)
7) Probe T	(Probe tables i.e. in the Probe are applied)
8) Probe C	(Probe coefficients i.e. in the Probe are applied)

3f Using Tempmaster PRO to obtain a secondary Calibration

There are two ways in which a non-calibrated sensor can be converted into a secondary standard using a 'sensor matched' Tempmaster PRO.

By means of CHANNEL A-B measurement. Connect the certified sensor to Channel A and the un-calibrated sensor to Channel B. The sensors can be of similar or dissimilar type, e.g. Pt100 certified sensor on Channel A and type K thermocouple on T/C B.

NOTE: A-B display values at various stable, isothermal calibration temperatures and compute sensor B corrected values accordingly.

Connect the certified sensor to Channel A and the un-calibrated sensor to Channel B.

Compare direct A and B readings in turn at various stable, isothermal calibration temperatures and compute sensor B corrected values accordingly. On this basis, a range of values can be obtained for use in 'correct B' matching (procedure as section 3iii)

3g On-Board Logging

View Log

Select 'LOGGING' in the MENU. Press 'ENTER' to view, write, start, erase log. Select the required memory slot (1 to 15) and enter the logging parameters. Follow the on-screen prompts. Press 'ESCAPE' to exit the logging menu.

3h Error indications

The Tempmaster PRO has several modes of error indication according to internal or external problems as follows:

DISPLAY	CAUSE
BROKEN PROBE	Open circuit sensor or sensor not connected to input
OUT OF RANGE	Thermocouple ranges only; input mV value outside calibration range (below min.Value or above full span value)
ILLEGAL A-B MODE	A-B mode will only operate with C, F or Kelvin units
CAL LOST	All calibration values corrupted or lost. Perform re-calibration or RETURN TO FACTORY
CPU ERROR	Failure of the two microprocessors to communicate. RETURN TO FACTORY
BATTERY FLAT PLEASE RE-CHARGE	Inadequate battery charge to sustain operation within specification

Note: During normal operation, if selected probe is disconnected from the instrument the display will indicate **BROKEN PROBE**. If the same probe is re-connected, normal operation will be resumed.

3i 3 or 4 Wire Recognition (Pt100)

The Tempmaster PRO requires a minimum of 80 milliOhms lead resistance (e.g. 1 metre of 7 stranded 0.2mm Ω wire) to recognise a 4 wire probe. Otherwise the instrument will default (perhaps correctly) to 3 wire mode.

If simulating a sensor input or calibrating the instrument, ensure 80m Ω lead resistance between the resistance source and D plug (e.g. 1 metre of 7 x 0.2mm Copper Cable).

3j Variable Filter Rate

In high resolution mode (Pt100 inputs only), the sampling rate can be varied between 4 and 64 (i.e. the number of measurements averaged per display update). The selection is made via the edit filter menu obtained as follows:

A screenshot of the instrument's display showing the 'Main Menu' and 'Filter' options. The text is in a monospaced font and is centered on a light blue background.

Main Menu \square
Filter

Press 'MENU' then 'NEXT'. The edit filter menu is obtained.

The Display indicates: **SELECT FILTER LENGTH 0.1 SECONDS
EACH VALUE =**

Using the 'Up/Down' keys, enter the required value. Press 'ENTER' and the resultant value will be stored until changed by the user. Press 'ESCAPE' to return to the main display.

4. Operation with a PC

4a Install the Software

For use with a PC the software supplied with the Tempmaster PRO must be installed on the PC and communication established (on-line green indicator showing) via the USB lead supplied. System requirements for installing the software: Windows XP with at least one USB port. All Windows operating systems prior to XP do not support USB natively and are not recommended.

4b Control Panel

In the PRO Software window, double click on the 'PRO Control Panel' icon. The following window is opened:

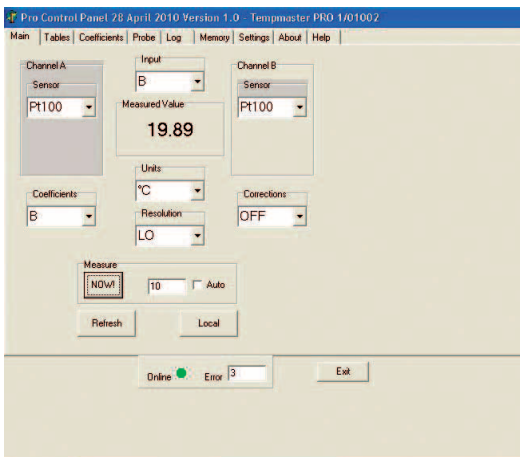

Note: When the control panel is opened subsequently, the tab selected prior to closing will be applicable.

The on-line indicator shows 'green' when communications between the PRO instrument and the PC are established (see 'settings' on page 16). Local control of the instrument is not possible (locked out) when communications between instrument and PC are established and 'Remote' selected (remote control). The front panel indicates 'REM'. To revert to local control of the instrument (via the front panel), click 'LOCAL'; remote control via the PC is disabled.

4c Sensor Selection

In the 'Main' window, the sensors currently selected for channel A and B are indicated in the relevant boxes. Alternative sensor types for each channel can be selected by clicking the drop down arrow to the right of the indicated sensor and clicking on the desired type.

Note: it is essential to ensure that the sensor type selected corresponds to the actual sensor type connected to the instrument.

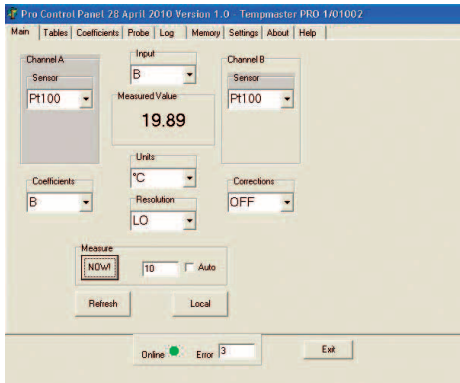

Note: Click 'MEASURE' after any changes or check 'AUTO' for the change to be displayed automatically.

4d Settings

Click on the 'SETTINGS' tab for port selection if required. In many cases this may not be required since communications may be established automatically. If not, simply click on the appropriate port.

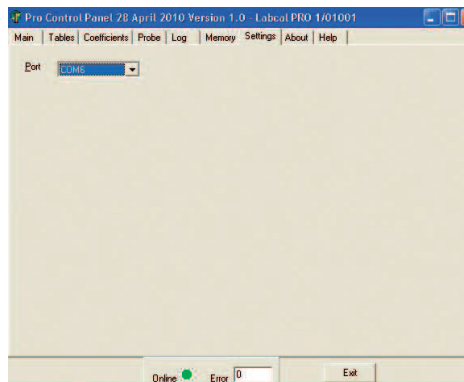

4e Input Channel

Select A or B from the 'INPUT' box in the top centre of the control panel; the measured value is displayed below in the 'MEASURED VALUE' box when 'MEASURE NOW' button is clicked.

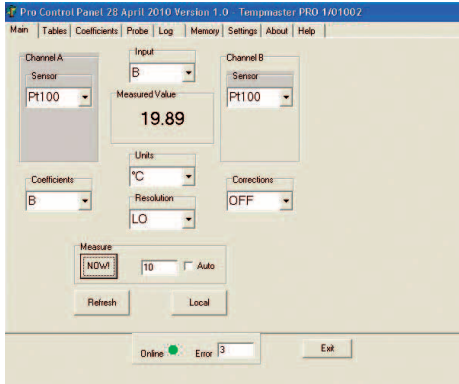

4f Units and Resolution

These are selected via the appropriate boxes in the 'Control Panel'.

4g Coefficients and Corrections

These are selected as required for each channel, their values having been set (or default settings) via screens obtained by selecting tables 'coefficients' and/or 'Tables'.

Matching to calibrated sensors (Tables Tab):

- i) Select the desired input A or B appropriate to the chosen calibrated probe.
- ii) Click on the 'TABLES' Tab

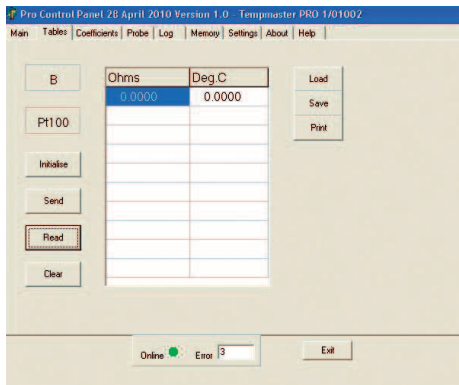

- iii) Click on 'INITIALISE' to clear any existing values.
- iv) Enter up to ten values of engineering units corresponding to the temperature as stated on the calibration certificate for the 'reference' probe and click 'SEND'; this sends to table of values to the instrument.
- v) Stored 'correction' values can be switched ON or OFF as required in the 'Main' window.
- vi) Clicking 'READ' displays stored values.
- vii) Clicking 'CLEAR' clears values entered in the table on the window (not from the instrument).
- viii) Click 'LOAD' to load a corrections table from file.
- ix) Click 'SAVE' to save the corrections table to file.
- x) Click 'PRINT' to print the corrections table.

4h Custom Coefficients

These can be used to effectively modify the transfer characteristic of a sensor if required. The default coefficients are those for ITS 90; if IPTG 68 was required for example, the appropriate values could be entered.

- i) The required channel, A or B as appropriate to the sensor in question must be selected in the 'MAIN' window.
- ii) Click on the 'COEFFICIENTS' tab.

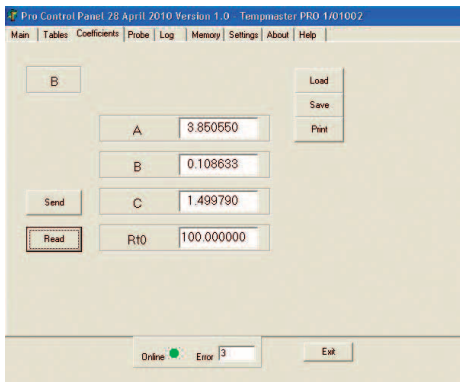

- iii) Enter the required values for A, B, C and Rto as appropriate and click 'SEND' to send these values to the instrument; existing values will be overwritten.
- iv) Click 'READ' to see stored values at any time.
- v) Click 'LOAD' to load a set of coefficients from file.
- vi) Click 'SAVE' to save file.
- vii) Click 'PRINT' to print the coefficients.

4i SMART Probe

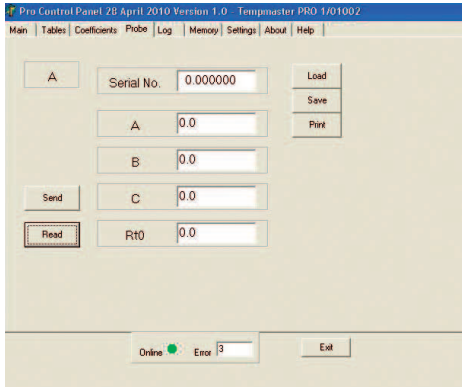

Click on the 'Probe' tab to view the SMART probe window. This window is very similar to the one in the 'Tables' tab and the values stored in the probe can be read, entered or edited.

The probe Serial No. is shown and can be modified to suit.

Click SAVE to save the values to the probe as required.

4j Log

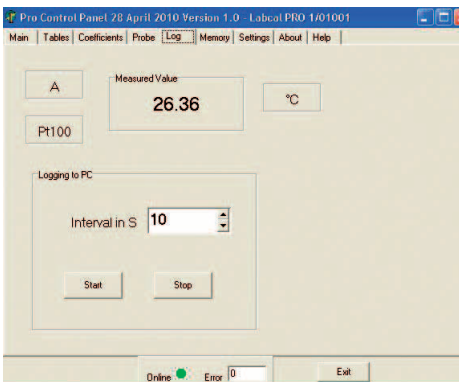

This tab is used to control PC logging of measured values (i.e. readings are saved to file on the PC and not on-board the instrument). Readings are saved in the same folder as that in which the PRO software resides.

The selected channel (as configured in the 'Main' tab) is indicated and the selected sensor type. Measured value and units are also displayed. In the 'Logging to PC' panel, the logging interval is selected (1 to 3600 seconds). Logging commences when 'START' is clicked and stopped when 'STOP' is clicked.

4k Memory

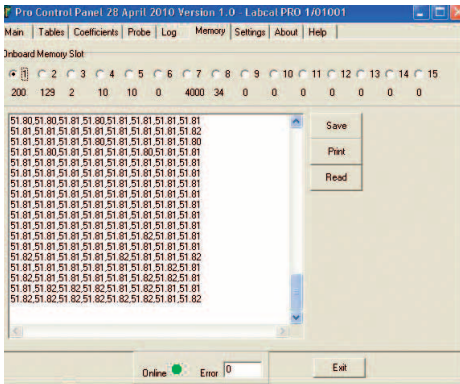

In this tab, readings stored on board the instrument can be retrieved and saved to file (normally in the same folder which contains the PC software).

- i) Click 'READ' to read the values.
- ii) Click 'SAVE' to save the readings to file.
- iii) Click 'PRINT' to print the readings.

5. Analogue (D to A) re-transmission output

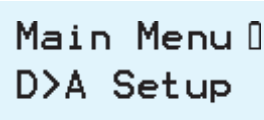

In the main menu, scroll down to D>A Setup and press 'ENTER'. Follow the on-screen prompts to set up zero and span (degrees C) values. Press 'ENTER' to Edit Zero (value) and press 'NEXT' to highlight the existing value; press 'NEXT' repeatedly to obtain the desired value. Then press 'ENTER' to store the specified value. Press 'ESCAPE' and then 'NEXT'; repeat the procedure for the span value.

6. Instrument Re-Calibration

It is recommended that this procedure is carried out by Labfacility or by an accredited laboratory facility.

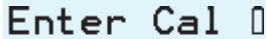

Enter Cal █

Calibration must only be performed by an authorised person and in the laboratory with a steady ambient temperature; access to the calibration level of the software is via a 5 digit 'engineer' code; this must be entered at the prompt by pressing 'INC/DEC' sequentially for the first digit. Then press 'UNITS+SENSOR' to move to the next digit.



Password? █
Use SENSOR and CHAN
to select Digit
00000
Engineer Code

Re-calibration of the Tempmaster PRO is unlikely to be required routinely since its design provides very good short and long term stability.

Item required for calibration:

- i) A highly accurate resistance source providing 100.000 Ω and 250.000 Ω (No lead resistance).
- ii) Suitable connectors for the rear panel sockets as appropriate.

**CAUTION – Do not proceed unless all specified items are available.
Failure to do so may invalidate the warranty.**

Connect a 100 Ohm resistance to the PRT-A input port. The instrument displays the value of the 100 Ohm input according to its previous calibration. The instrument now measures the precise resistance and displays the value. Press 'ENTER' and the value is sampled and entered. Press 'ESCAPE' if calibration of the channel is not required.

a) *The display screen now shows;*

CALIBRATION
CH A PRT 100 OHMS

Connect a 250 Ohm resistance to the PRT-A port. The instrument now measures the precise resistance and displays the value. Press 'ENTER' and the value is sampled and entered.

b) *The display screen now shows;*

CALIBRATION
CH B PRT 100 OHMS

Repeat the procedure as in c) above but using the PRT-B input port.

c) *The display screen now shows;*

CALIBRATION
CH B PRT 250 OHMS

Repeat the procedure as in d) above but using the PRT-B input port.

7. Specifications

General

	Inputs/Ranges/Sensors
Type	Pt100 to IEC 751 (ITS 90 refers). -200°C to +850°C R ₀ = 100Ω 3 or 4 wire connection with automatic recognition (with manual override)
Overall Accuracy	± 0.01°C ± 0.0005% of span
Linearisation Conformity	Better than ± 0.01°C
Stability (vs ambient temperature)	Better than 0.0025°C per 1°C ambient change
Warm-up	Negligible under normal ambient conditions. Allow 5-10 minutes for full stability unless stored at low temperature, then 30 minutes minimum.
Pt100 Sensor Current	0.5mA
Resolution of data display	0.01
Variable filter	Sampling rate selectable between 4 and 64 (measurements averaged per reading).
Measurement Units	°C, °F, K, Ω
Measurement Modes	A, B or A-B.
Custom Calibration	Up to 10 calibration values can be allocated to Pt100 input A & B and to thermocouples input A & B. Values are retained in non-volatile memory until replaced by user. ITS 90 or IPTS 68 coefficients can be used for custom calibration.
Smart Sensor Connection	Correction values stored in connector
Null Function	Corrects differential temperature readout between two sensors to zero.
Sensor Lead Resistance	5Ω each lead maximum
Logging	8000 readings
Supply	Internal Lithium Ion rechargeable batteries. Mains 90-260V 50/60Hz universal adaptor included. Battery charge life up to 12 hours with full charge.

Tempmaster PRO Thermometer

Series Mode Rejection	60dB @ 50Hz (50mV RMS applied)
Common Mode Rejection	30V RMS applied between input and earth produces no measurable effect.
Display	128 x 64 pixel character OLED screen with diffused backlighting. Wide viewing angle, high contrast (adjustable).
Front Panel Controls	9 membrane push-keys to control all instrument functions
Mechanical/Case	Metal bench top case / adjustable tilt
Dimensions	Overall 190mm(W) x 70mm(H) x 250mm(D)
Weight	3.0kg approx.
Input Connections	2 x Pt100 via D type connectors
USB Serial Communications	Isolated, 9600 Baud, 8 data, no parity, 1 stop bit. Remote control and measure.
PC Software (standard)	Supplied as standard on CD-ROM. Remote control and measure: Log readings to file/Download to PC/Programming corrections
Analogue Output (standard)	User programmable, 0 to 5V

Application Note:

Inputs are not isolated in the instrument, which is primarily designed for laboratory applications and site calibration of industrial temperature sensors. Probes connected to the instrument must therefore be isolated from high voltage pick-up.

Assessories and Order Codes

Tempmaster PRO is supplied complete with switch mode power supply (90-260V, 50/60Hz), two Pt100 “D” connectors, operating manual and PC software.

Precision Pt100 Probes

Stainless steel probes, 6mm diameter with 2m screened PTFE lead Pt100 Probes and connector

LP - L250: 250mm long, maximum 250°C

LP - H450: 350mm long, maximum 450°C

UKAS Calibration

LP - UKAS: UKAS calibration for instrument alone.

LP - SYS.CAL: UKAS calibration of instrument and sensor together at five points.

LP - COR.CAL: UKAS calibration of instrument and sensor together at five points, after initial calibration of sensor only and programming of corrections.

Accessories

LP - TBLK3: Terminal Block for connection of 3 wire Pt100s

LP - TBLK4: Terminal Block for connection of 4 wire Pt100s



LABFACILITY

TEMPERATURE & PROCESS TECHNOLOGY

To receive our regular email newsletter, please register your details on our website

www.labfacility.co.uk

SOUTHERN UK & EXPORT DIVISION: Units 5,6 & 7, Block K, Southern Cross Industrial Estate, Shripney Road, Bognor Regis, West Sussex PO22 9SE

Export Sales: tel: +44(0)1243 871287 fax: +44(0)1243 871281
email: exportsales@labfacility.co.uk

Southern UK Sales: tel: +44(0)1243 871280 fax: +44(0)1243 871281
email: southernsales@labfacility.co.uk

NORTHERN UK DIVISION: Eden Place, Unit 3b Outgang Lane, Dinnington, Sheffield S25 3QT

Northern UK Sales: tel: +44(0)1909 569446 fax: +44(0)1909 550632
email: northernsales@labfacility.co.uk



Certificate No. 4746

Data ref: